

Classical Raised Panel, 2 Flutes

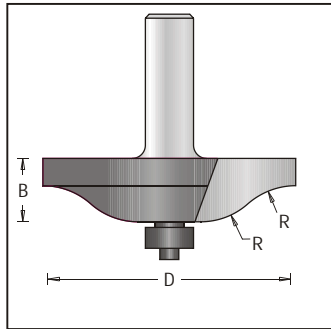

Tool no.	D	Shank	B	R	Length	Parts	Category
126R8-63	2 1/2"	1/2"	1/2"	1/8"	2 3/8"	D	R

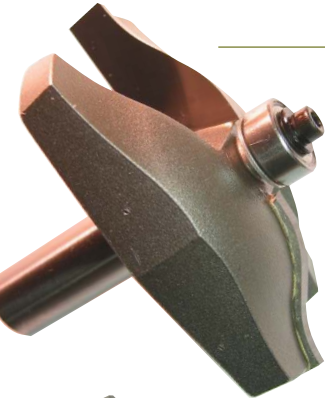

Ogee Fillet Raised Panel, 2 Flutes

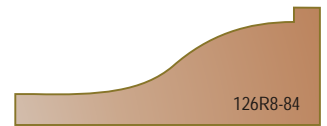
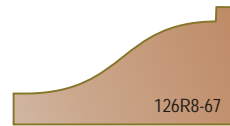

Tool no.	D	Shank	B	R	Length	Parts	Category
126R8-67	2 5/8"	1/2"	11/16"	3/4"	2 9/16"	D	R
126R8-84	3 3/8"	1/2"	5/8"	7/8"	2 1/2"	D	R

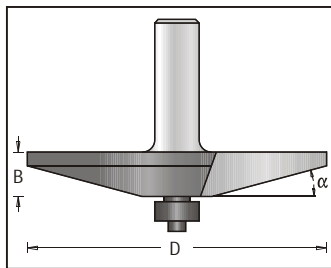
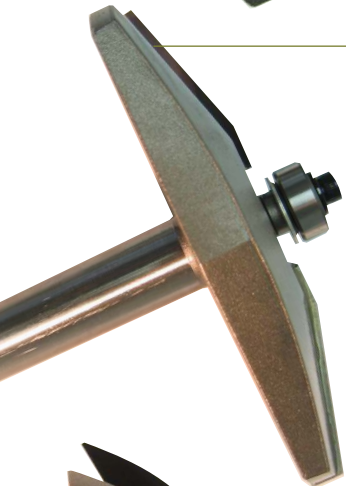

Provincial Raised Panel, 2 Flutes



Tool no.	D	Shank	B	α	Length	Parts	Category
126R8-85	3 3/8"	1/2"	1/2"	15°	2 3/8"	D	R

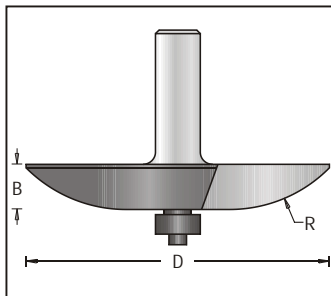

Cove Raised Panel, 2 Flutes



Tool no.	D	Shank	B	R	Length	Parts	Category
126R8-86	3 3/8"	1/2"	1/2"	1 9/16"	2 3/8"	D	R