

New Age Profile Routing Tools with Replaceable Tips

Multi Profile System Type A

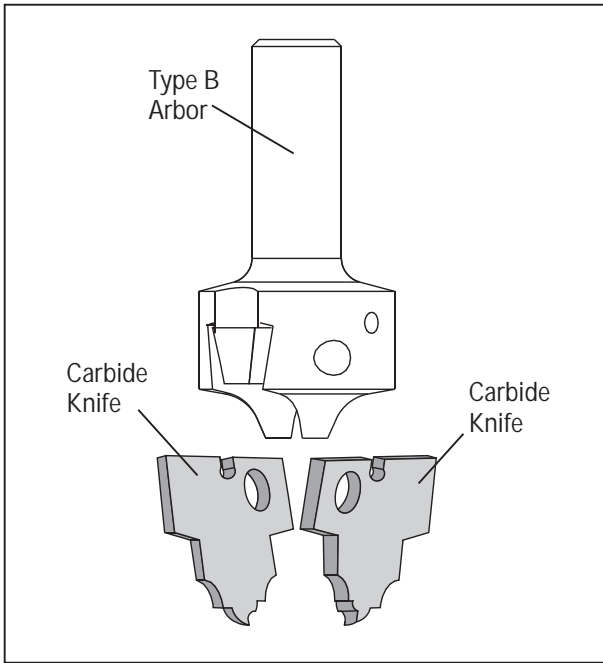
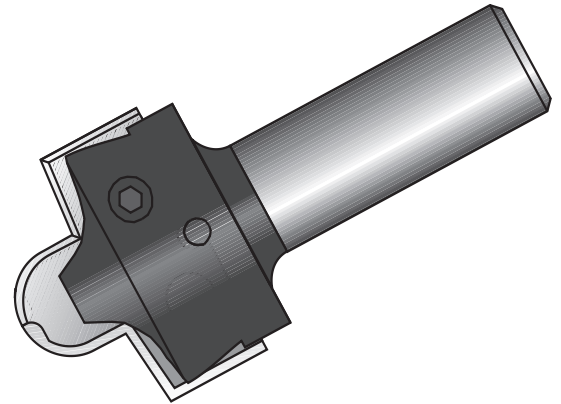

It's a whole workshop of options in a single Router Bit

The new Multi Profile System gives you a wide range of profiling options in a single Router bit with Replaceable Carbide Tips.

This New Age Router bit System, developed by DIMAR, puts the power of greater precision, better performance and higher versatility into your hands.

Why Choose The Multi Profile System?

Durability

Replaceable Carbide knives are harder, stronger, longer lasting and perform better on abrasive materials.

Versatility

One Router Bit gives you a wide variety of profiling options and can be used with Portable, or Industrial CNC machinery.

Safety

Chip Limitation design for safe operation. All Router bits have been tested for maximum stress by the German institute of Technology.

Service free

The Router Bits do not need sharpening. Simply replace the carbide knives.

Accuracy

Carbide knives have consistent and precise profiles for optimum and continued operation without adjustments.

Cost effective

Longer lasting knives, better performance, down time is minimal.

Only Carbide Knives are replaced.

Easy to replace

Step by step instructions included, so you can do it yourself.

Core Box, 2 Flute, Type B

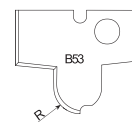
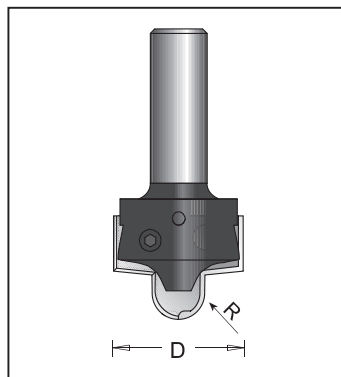
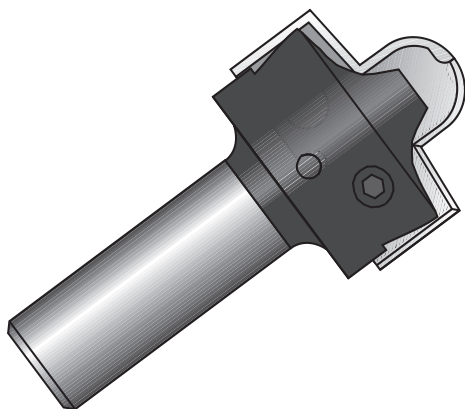

Tool no.	Blade #	D	Shank	R	Length	Category
N4-B53	B53	1 1/4"	1/4"	1/4"	2 1/4"	I
N8-B53	B53	1 1/4"	1/2"	1/4"	2 5/8"	I