

Multi Profile Cutters

Start with the cutter head first (knives #3319140 included), and then build up your Multi Profile Cutter System simply by purchasing additional pairs of knives from the selection on the following pages.

Multi Profile Cutter System - 40mm or 50mm Width

The system offers a wide variety of profiles to produce Mouldings, Tongue & Groove, Glue Joints and different shapes that are not available in router bits. The knives are mounted and locked in position by two pins and a locking screw. The wedge provides a safe and secure backing to the knives. The knives are indexable and will produce the same profile time after time. The cutter head is made from premium Steel. The Multi Profile Cutter System is suitable for low powered machines with 1 h.p. or more.

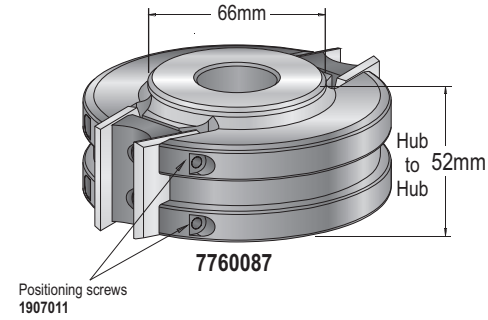

CUTTER HEAD for 40mm or 50mm knives with limiters **NEW**

Tool no.	Dia.	Width	Bore	Teeth	t	Category	RPM
*7760087	114mm(4.5")	40mm & 50mm	1 1/4"	2	10.37mm	C	5000-8000
**7710617	100mm	40mm	1 1/4"	2	10.80mm	C	8400

2 knives (3319140) & 2 Limiters (3419140) & Allen Key included
 Replacement Parts: Wedge 1998010 ; Screw (M8x12) 1930266 ; Allen key MPC-KEY

*Please note: This cutter is suitable for Tool Steel knives only.

**Please note: This cutter is suitable for Tool Steel and Carbide Tipped knives.

BLANK KNIVES FOR 50mm ONLY (price per pack of 2 knives)

Tool no.	B	Category
3500034	34mm	C

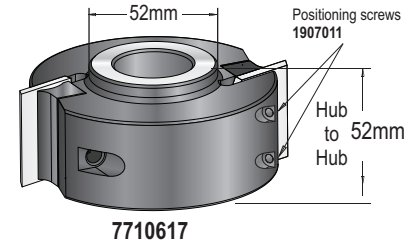
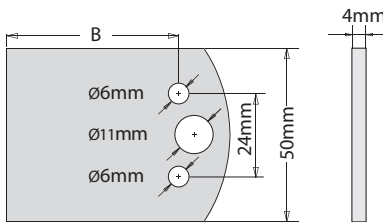

t = Distance between centre holes and outside of cutter

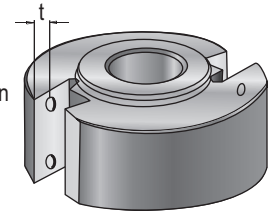

Multi Profile Cutter System - Profile Knives-50mm

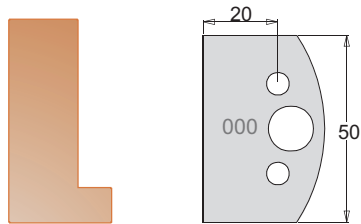

Knife 3300050
 Limiter 3400050

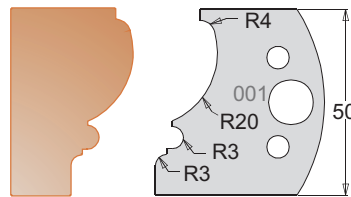

Knife 3300150
 Limiter 3400150

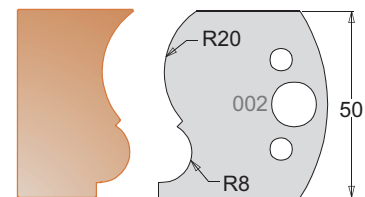

Knife 3300250
 Limiter 3400250

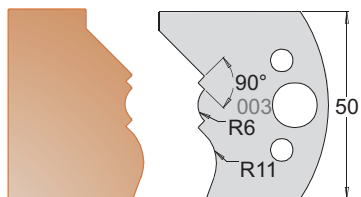

Knife 3300350
 Limiter 3400350

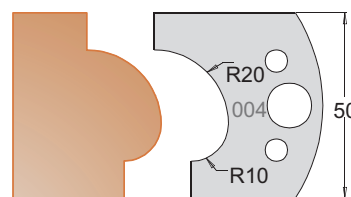

Knife 3300450
 Limiter 3400450

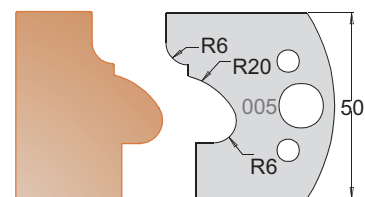

Knife 3300550
 Limiter 3400550

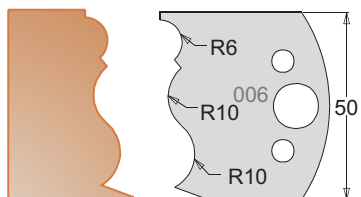

Knife 3300650
 Limiter 3400650

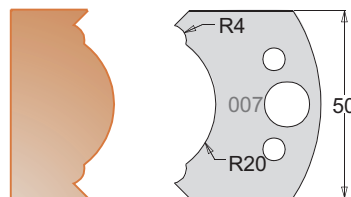

Knife 3300750
 Limiter 3400750



Knife 3300850
 Limiter 3400850

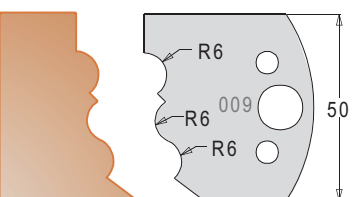

Knife 3300950
 Limiter 3400950

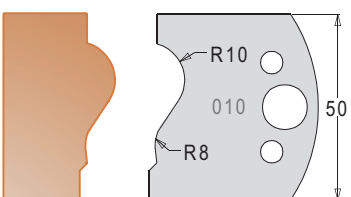

Knife 3301050
 Limiter 3401050

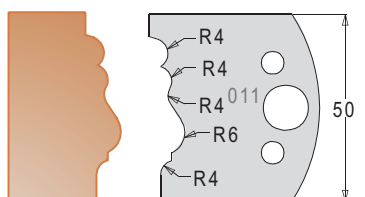

Knife 3301150
 Limiter 3401150

Multi Profile Cutter System - Profile Knives-50mm

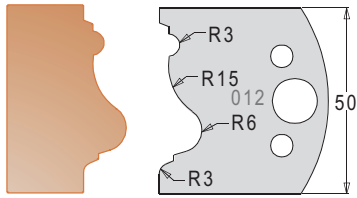

Knife 3301250
Limiter 3401250

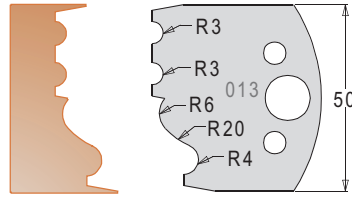

Knife 3301350
Limiter 3401350

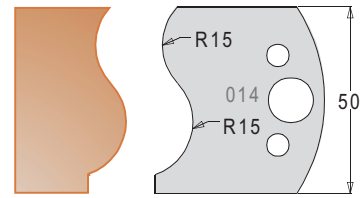

Knife 3301450
Limiter 3401450

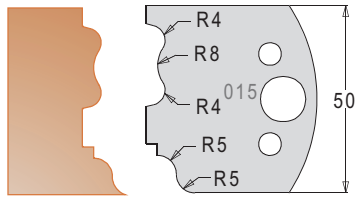

Knife 3301550
Limiter 3401550

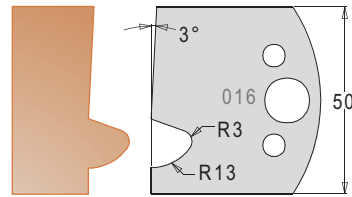

Knife 3301650
Limiter 3401650

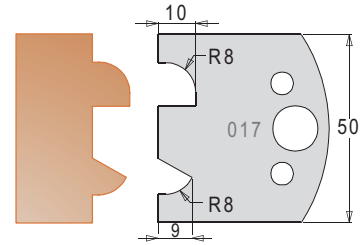

Knife 3301750
Limiter 3401750

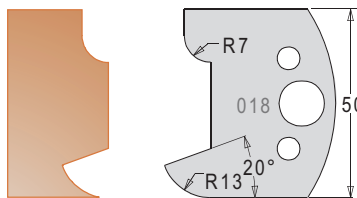

Knife 3301850
Limiter 3401850

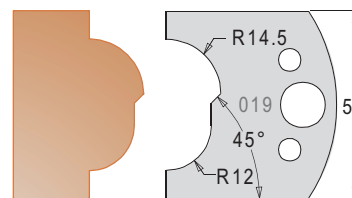

Knife 3301950
Limiter 3401950

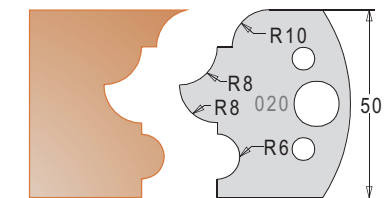

Knife 3302050
Limiter 3402050

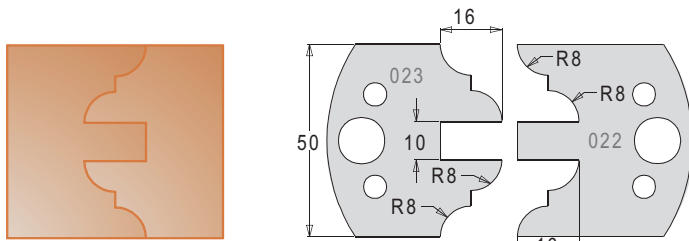

Knife 3302350
Limiter 3402350

Knife 3302250
Limiter 3402250

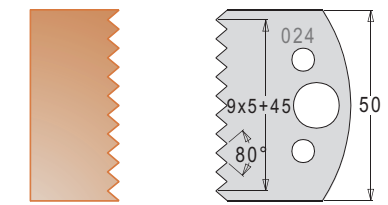

Knife 3302450
Limiter 3402450

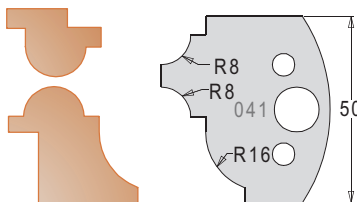

Knife 3304150
Limiter 3404150

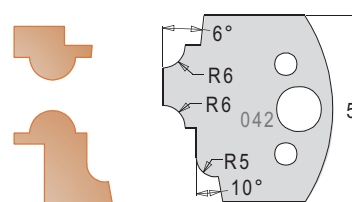

Knife 3304250
Limiter 3404250

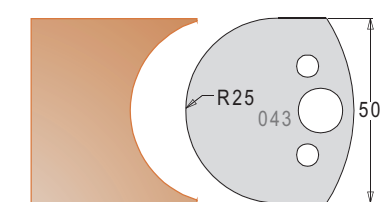

Knife 3304350
Limiter 3404350

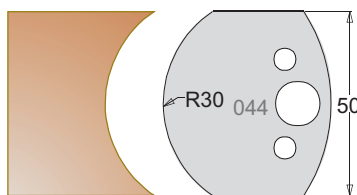

Knife 3304450
Limiter 3404450

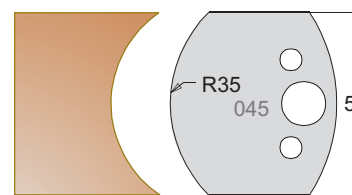

Knife 3304550
Limiter 3404550

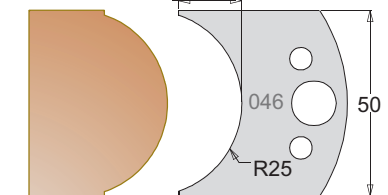

Knife 3304650
Limiter 3404650

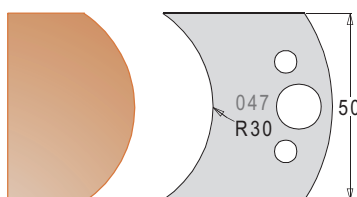

Knife 3304750
Limiter 3404750

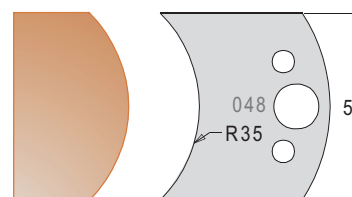

Knife 3304850
Limiter 3404850

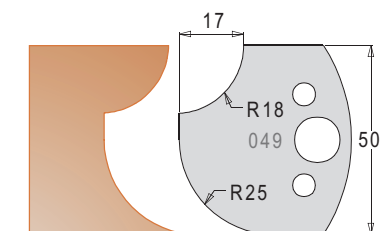

Knife 3304950
Limiter 3404950

Multi Profile Cutter System - Profile Knives-50mm

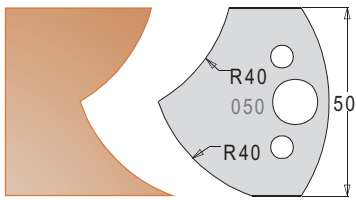

Knife 3305050
Limiter 3405050

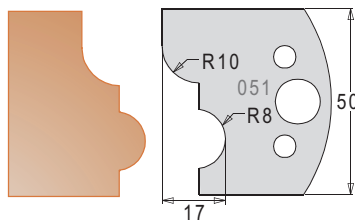

Knife 3305150
Limiter 3405150

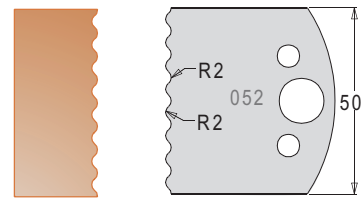

Knife 3305250
Limiter 3405250

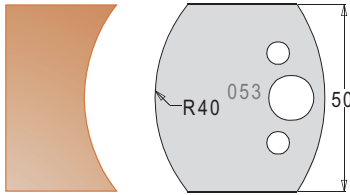

Knife 3305350
Limiter 3405350

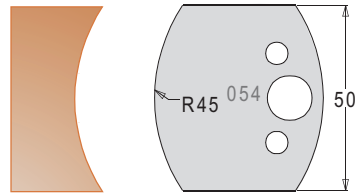

Knife 3305450
Limiter 3405450

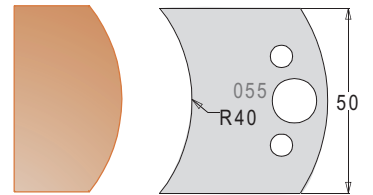

Knife 3305550
Limiter 3405550

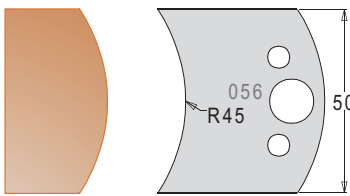

Knife 3305650
Limiter 3405650

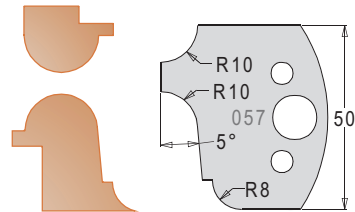

Knife 3305750
Limiter 3405750

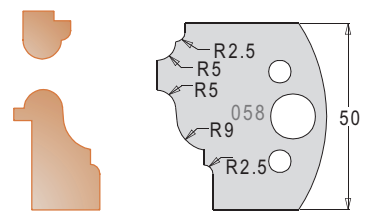

Knife 3305850
Limiter 3405850

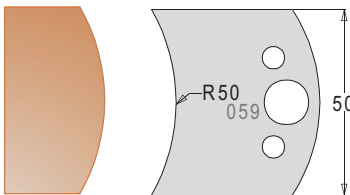

Knife 3305950
Limiter 3405950

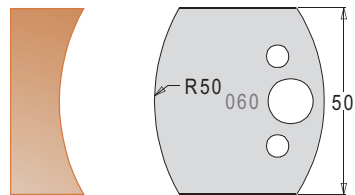

Knife 3306050
Limiter 3406050

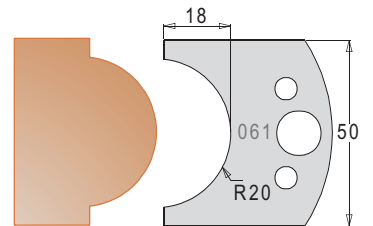

Knife 3306150
Limiter 3406150

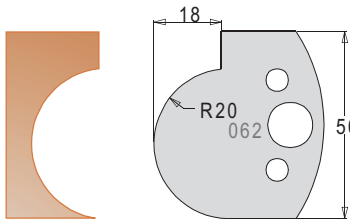

Knife 3306250
Limiter 3406250

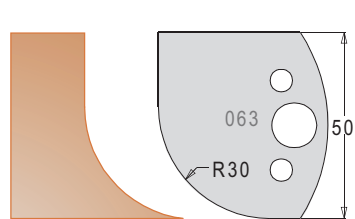

Knife 3306350
Limiter 3406350

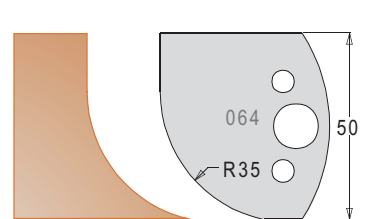

Knife 3306450
Limiter 3406450

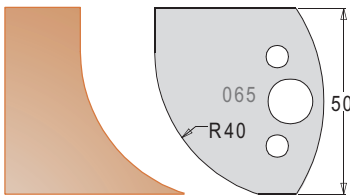

Knife 3306550
Limiter 3406550

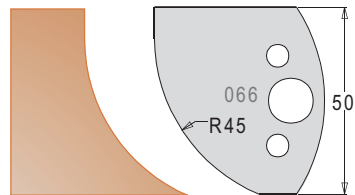

Knife 3306650
Limiter 3406650

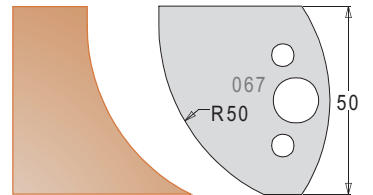

Knife 3306750
Limiter 3406750

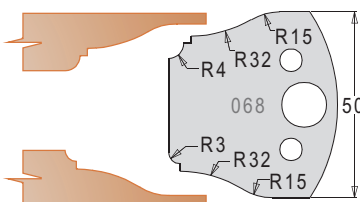

Knife 3306850
Limiter 3406850

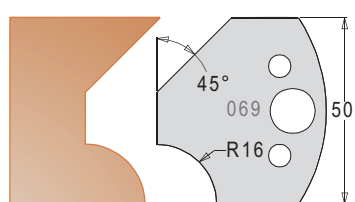

Knife 3306950
Limiter 3406950