

# Make your own Multi Profile Cutter set!

Start with the cutter head first (knives #3319140 included), and then build up your Multi Profile Cutter System simply by purchasing additional pairs of knives from the selection on the following pages.

## Multi Profile Cutter System - 40mm or 50mm Width

The system offers a wide variety of profiles to produce Mouldings, Tongue & Groove, Glue Joints and different shapes that are not available in router bits. The knives are mounted and locked in position by two pins and a locking screw. The wedge provides a safe and secure backing to the knives. The knives are indexable and will produce the same profile time after time. The cutter head is made from premium Steel. The Multi Profile Cutter System is suitable for low powered machines with 1 h.p. or more.

### CUTTER HEAD

Tool no.	Dia.	Width	Bore	Teeth	t	Category	RPM
*7710042	68mm	40mm	3/4"	2	10.25mm	C	9000
**7710617	100mm	40mm	1 1/4"	2	10.80mm	C	8400

2 knives (3319140) and Allen Key included

Replacement Parts: Wedge MPC-WEDGE ; Allen screw MPC-SCREW; Allen key MPC-KEY

\*Please note: This cutter is suitable for Tool Steel knives 40mm width only

\*\*Please note: This cutter is suitable for Tool Steel and Carbide Tipped knives 40mm or 50mm width

Please note: 1907011 sealed screw

### CUTTER HEAD for 40mm or 50mm knives with limiters NEW

Tool no.	Dia.	Width	Bore	Teeth	t	Category	RPM
*7760087	114mm(4.5")	40mm & 50mm	1 1/4"	2	10.37mm	C	5000-8000

2 knives (3319140) & 2 Limiters (3419140) & Allen Key included

Replacement Parts: Wedge 1998010 ; Screw (M8x12) 1930266 ; Allen key MPC-KEY

\*Please note: This cutter is suitable for Tool Steel knives only.

Please note: 1907011 sealed screw

### BLANK KNIVES for 40mm ONLY

(price per pack of 2 knives)

Tool no.	B	Category
3300030	18mm	C
3300036	24mm	C
3300039	27.5mm	C
3300046	33mm	C

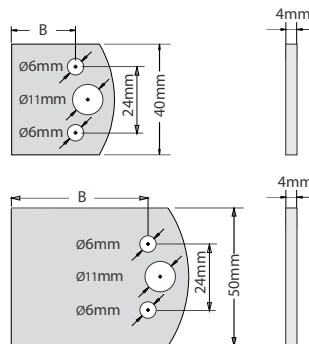

### BLANK KNIVES FOR 50mm ONLY

(price per pack of 2 knives)

Tool no.	B	Category
3500034	34mm	C

Some profiles are available in Carbide Tipped (TCT) on the following pages.

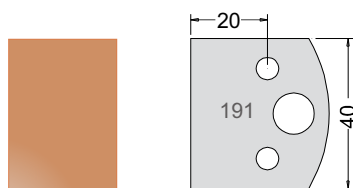

Knife 3319140  
Limiter 3419140

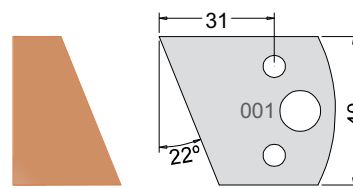

Knife 3300140  
Limiter 3400140

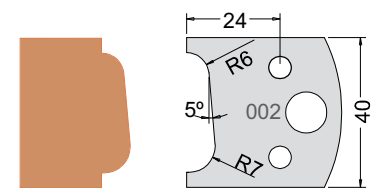

Knife 3300240  
Limiter 3400240

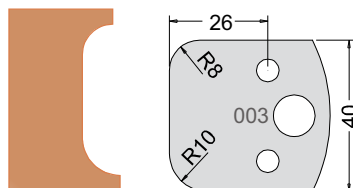

Knife 3300340  
Limiter 3400340

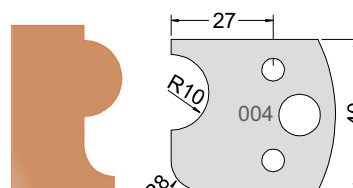

Knife 3300440  
Limiter 3400440

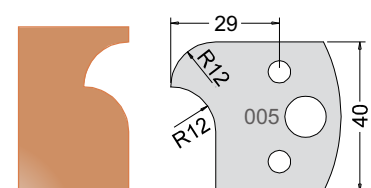

Knife 3300540  
Limiter 3400540

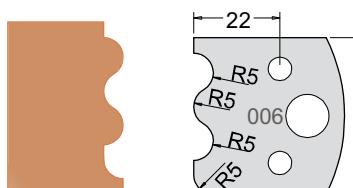

Knife 3300640  
Limiter 3400640

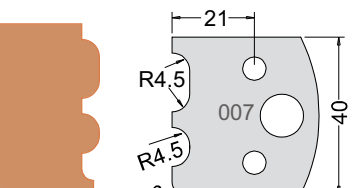

Knife 3300740  
Limiter 3400740

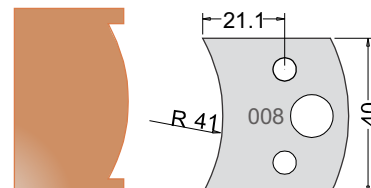

Knife 3300840  
Limiter 3400840

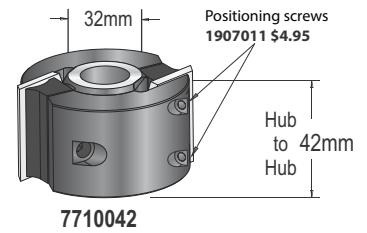

7710042

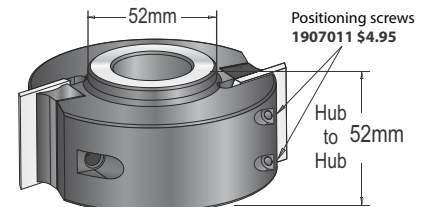

7710617

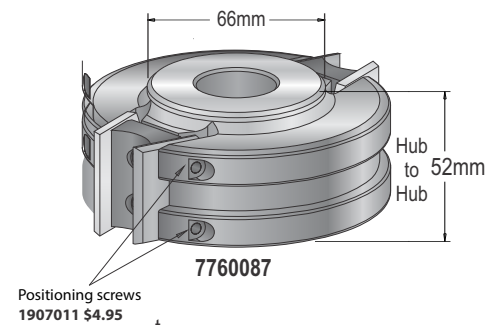

7760087

t = Distance between centre holes and outside of cutter

### Multi Profile Cutter System - Profile Knives-40mm

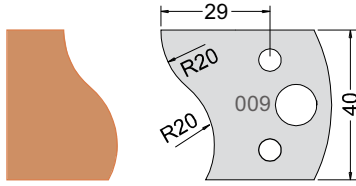

Knife 3300940  
Limiter 3400940

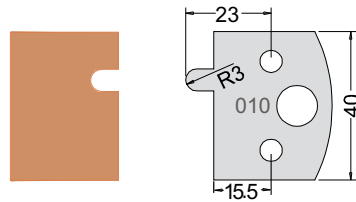

Knife 3301040  
Limiter 3401040

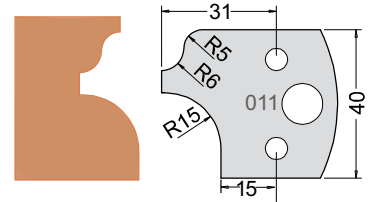

Knife 3301140  
Limiter 3401140

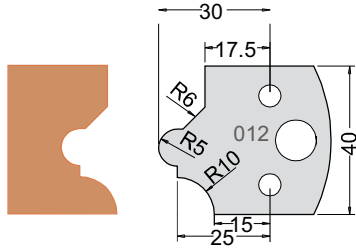

Knife 3301240  
Limiter 3401240

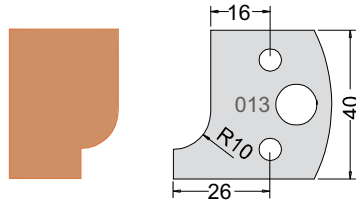

Knife 3301340  
Limiter 3401340

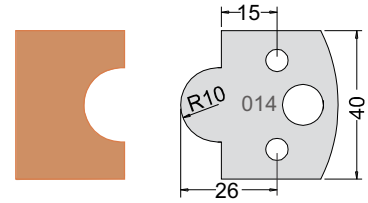

Knife 3301440  
Limiter 3401440

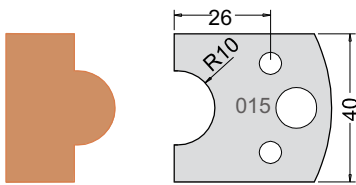

Knife 3301540  
Limiter 3401540

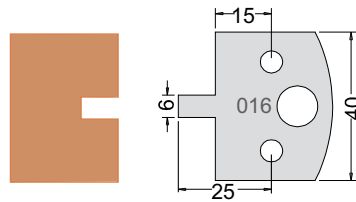

Knife 3301640  
Limiter 3401640  
TCT 3301642

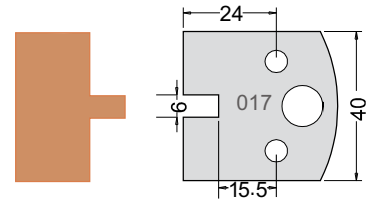

Knife 3301740  
Limiter 3401740  
TCT 3301742

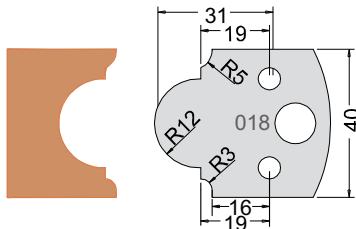

Knife 3301840  
Limiter 3401840

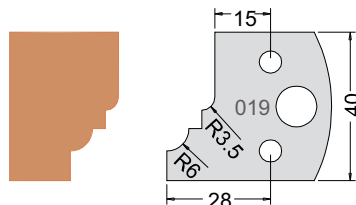

Knife 3301940  
Limiter 3401940

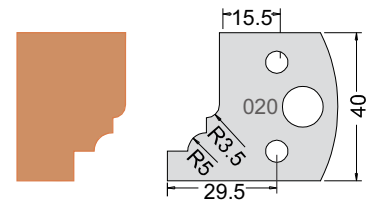

Knife 3302040  
Limiter 3402040

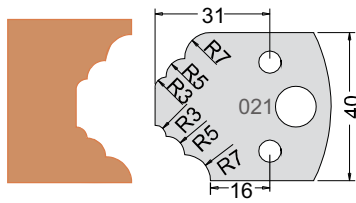

Knife 3302140  
Limiter 3402140

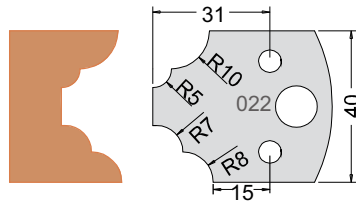

Knife 3302240  
Limiter 3402240

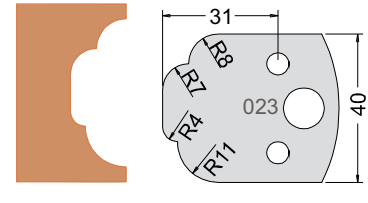

Knife 3302340  
Limiter 3402340

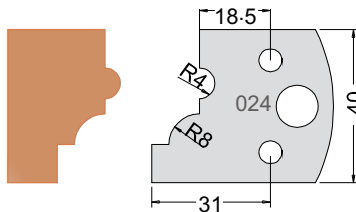

Knife 3302440  
Limiter 3402440

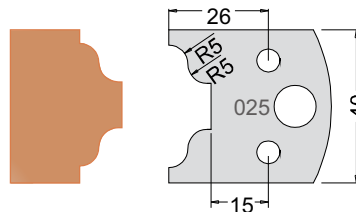

Knife 3302540  
Limiter 3402540

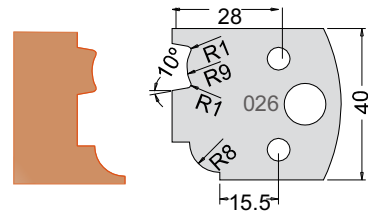

Knife 3302640  
Limiter 3402640

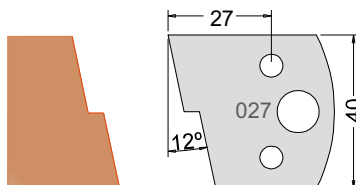

Knife 3302740  
Limiter 3402740

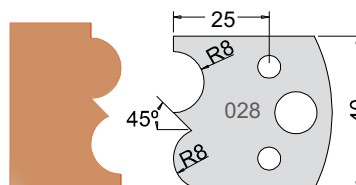

Knife 3302840  
Limiter 3402840

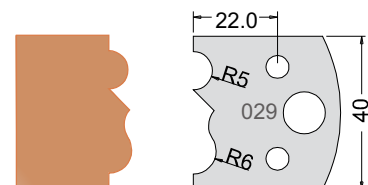

Knife 3302940  
Limiter 3402940

Multi Profile Cutter System - Profile Knives-40mm

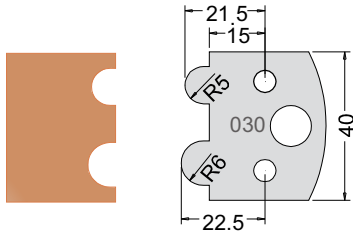

Knife 3303040  
Limiter 3403040

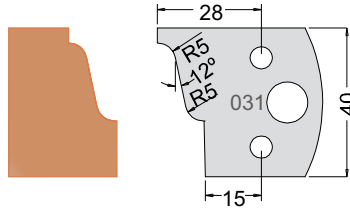

Knife 3303140  
Limiter 3403140

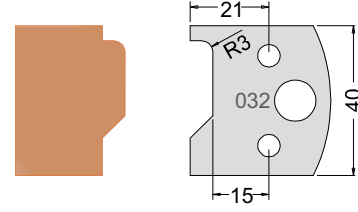

Knife 3303240  
Limiter 3403240

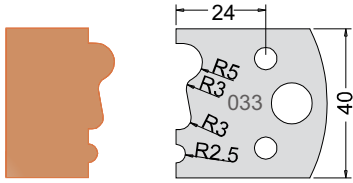

Knife 3303340  
Limiter 3403340

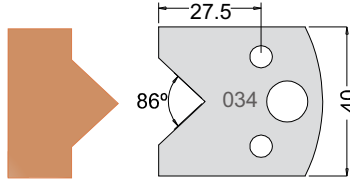

Knife 3303440  
Limiter 3403440

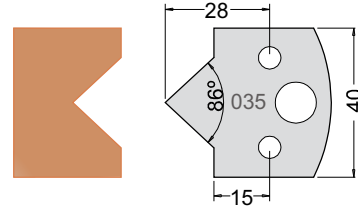

Knife 3303540  
Limiter 3403540

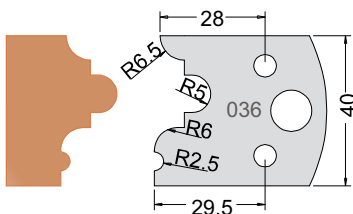

Knife 3303640  
Limiter 3403640

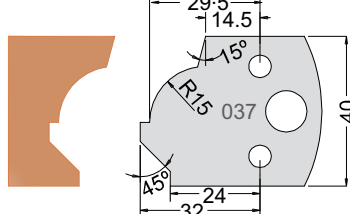

Knife 3303740  
Limiter 3403740

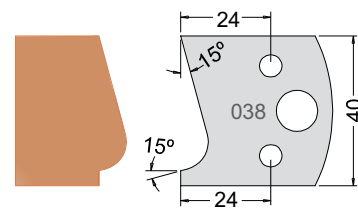

Knife 3303840  
Limiter 3403840

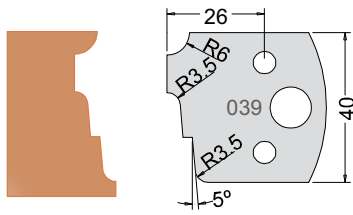

Knife 3303940  
Limiter 3403940

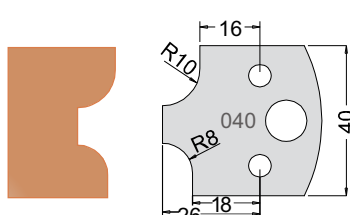

Knife 3304040  
Limiter 3404040

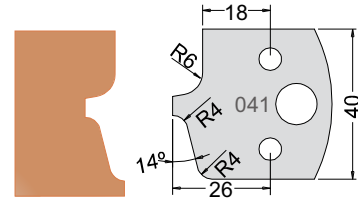

Knife 3304140  
Limiter 3404140

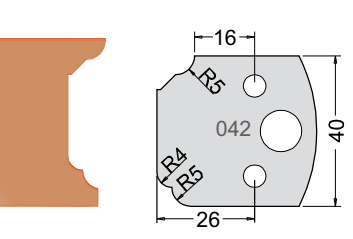

Knife 3304240  
Limiter 3404240

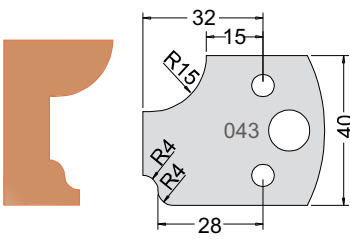

Knife 3304340  
Limiter 3404340

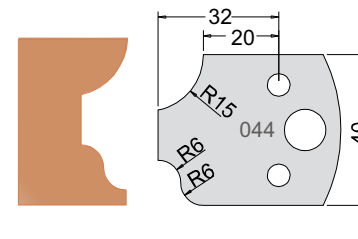

Knife 3304440  
Limiter 3404440

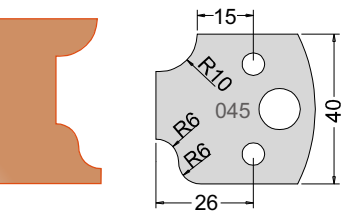

Knife 3304540  
Limiter 3404540

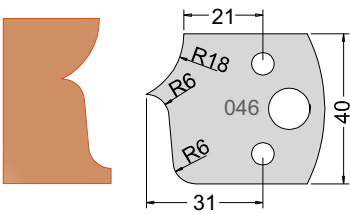

Knife 3304640  
Limiter 3404640

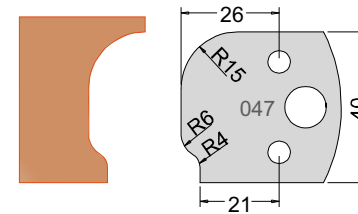

Knife 3304740  
Limiter 3404740

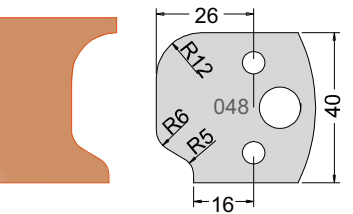

Knife 3304840  
Limiter 3404840

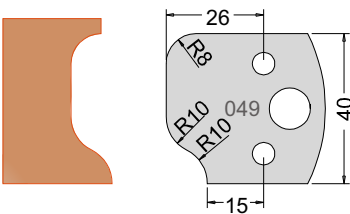

Knife 3304940  
Limiter 3404940

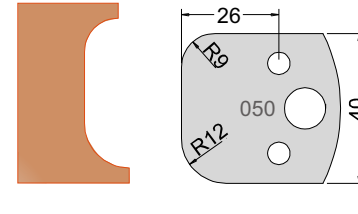

Knife 3305040  
Limiter 3405040

Multi Profile Cutter System - Profile Knives-40mm

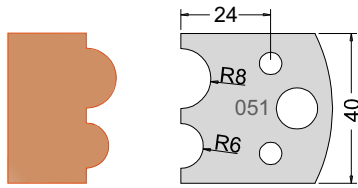

Knife 3305140  
Limiter 3405140

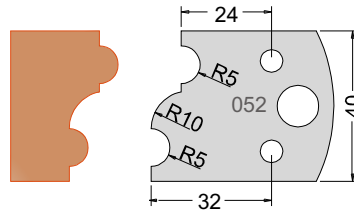

Knife 3305240  
Limiter 3405240

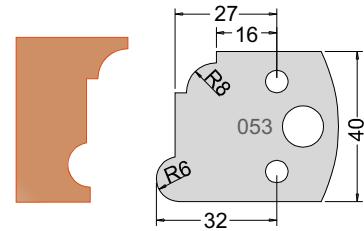

Knife 3305340  
Limiter 3405440

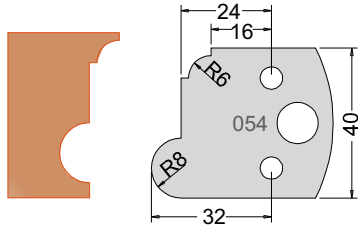

Knife 3305440  
Limiter 3405440

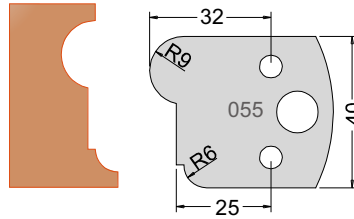

Knife 3305540  
Limiter 3405540

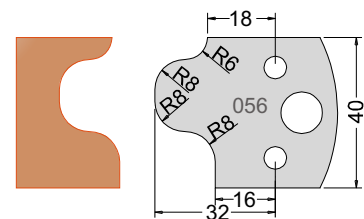

Knife 3305640  
Limiter 3405640

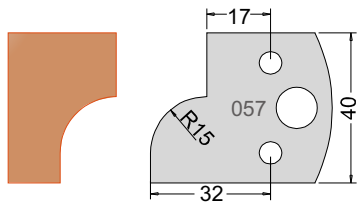

Knife 3305740  
Limiter 3405740

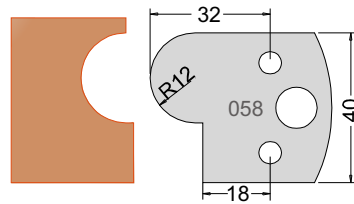

Knife 3305840  
Limiter 3405840

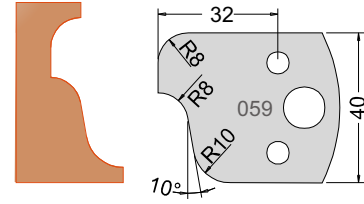

Knife 3305940  
Limiter 3405940

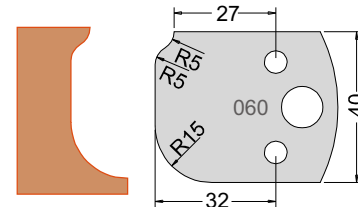

Knife 3306040  
Limiter 3406040

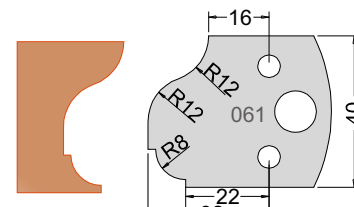

Knife 3306140  
Limiter 3406140

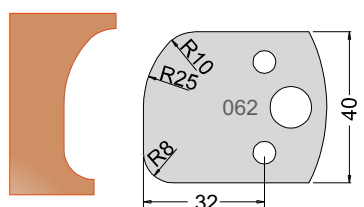

Knife 3306240  
Limiter 3406240

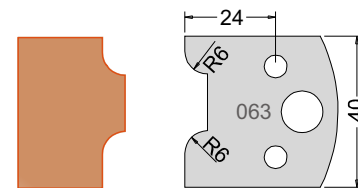

Knife 3306340  
Limiter 3406340

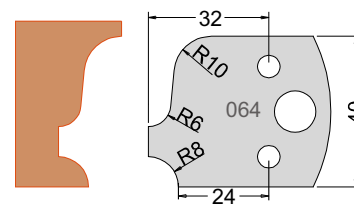

Knife 3306440  
Limiter 3406440

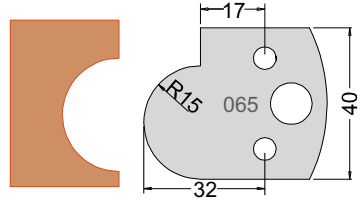

Knife 3306540  
Limiter 3406540

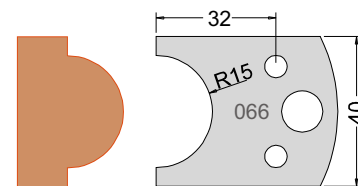

Knife 3306640  
Limiter 3406640  
TCT 3306642

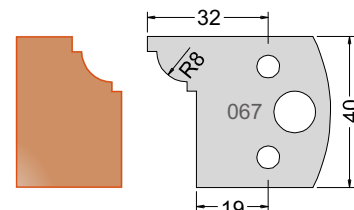

Knife 3306740  
Limiter 3406740

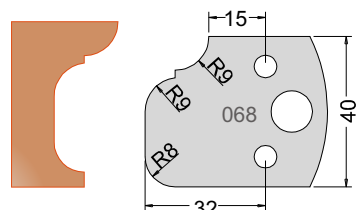

Knife 3306840  
Limiter 3406840

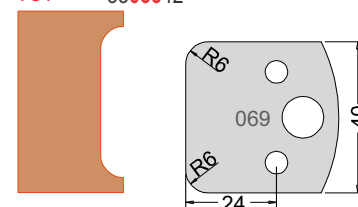

Knife 3306940  
Limiter 3406940

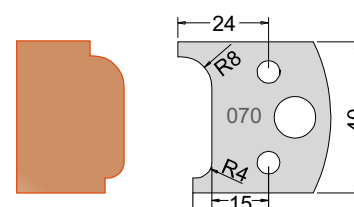

Knife 3307040  
Limiter 3407040

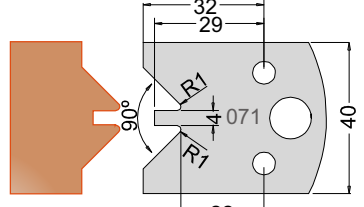

Knife 3307140  
Limiter 3407140

### Multi Profile Cutter System - Profile Knives-40mm

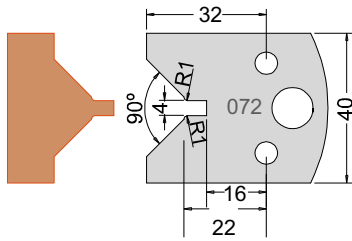

Knife 3307240  
 Limiter 3407240

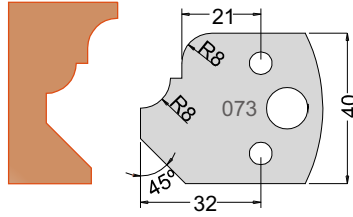

Knife 3307340  
 Limiter 3407340

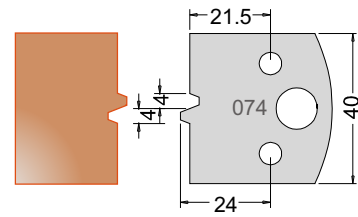

Knife 3307440  
 Limiter 3407440

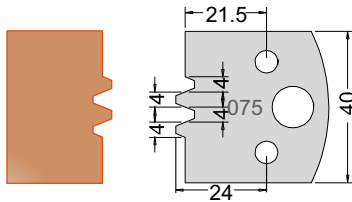

Knife 3307540  
 Limiter 3407540  
 TCT 3307542

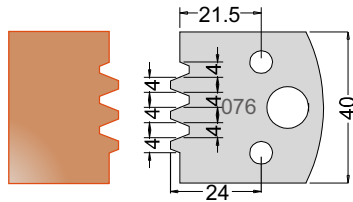

Knife 3307640  
 Limiter 3407640

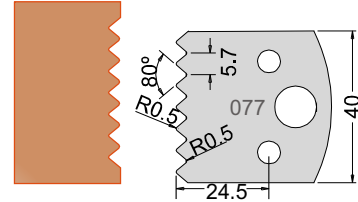

Knife 3307740  
 Limiter 3407740

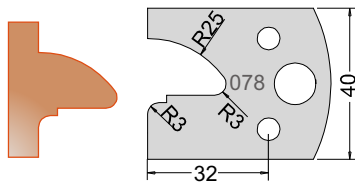

Knife 3307840  
 Limiter 3407840

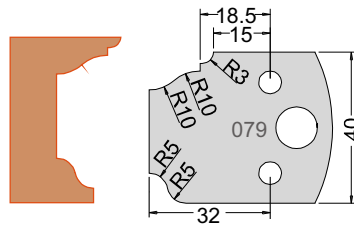

Knife 3307940  
 Limiter 3407940

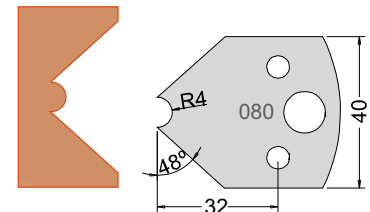

Knife 3308040  
 Limiter 3408040

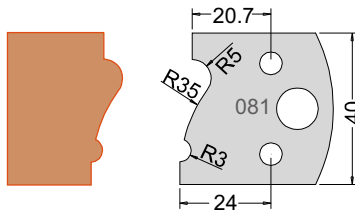

Knife 3308140  
 Limiter 3408140

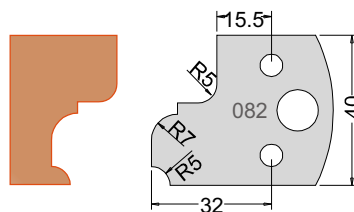

Knife 3308240  
 Limiter 3408240

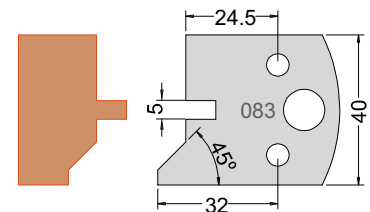

Knife 3308340  
 Limiter 3408340  
 TCT 3308342

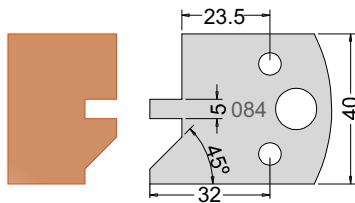

Knife 3308440  
 Limiter 3408440  
 TCT 3308442

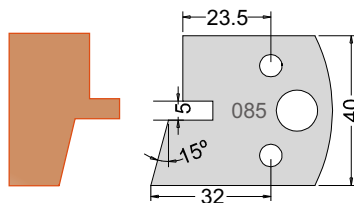

Knife 3308540  
 Limiter 3408540

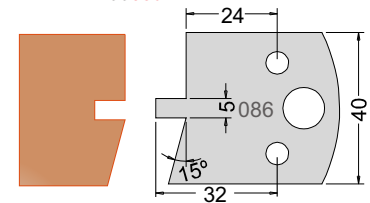

Knife 3308640  
 Limiter 3408640

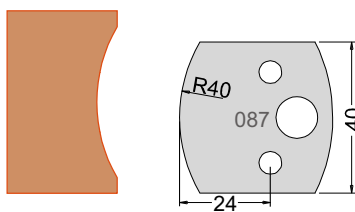

Knife 3308740  
 Limiter 3408740

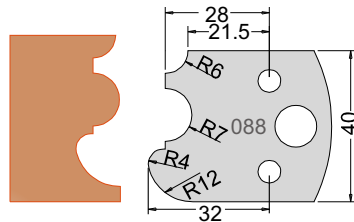

Knife 3308840  
 Limiter 3408840

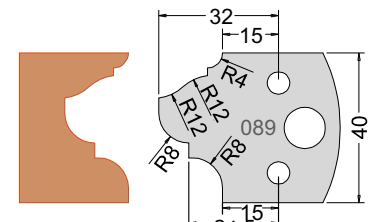

Knife 3308940  
 Limiter 3408940

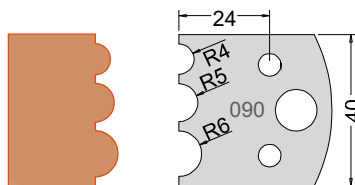

Knife 3309040  
 Limiter 3409040  
 TCT 3309042

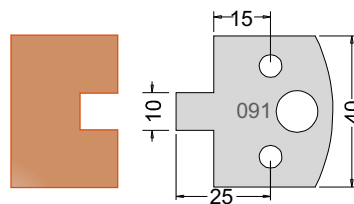

Knife 3309140  
 Limiter 3409140  
 TCT 3309142

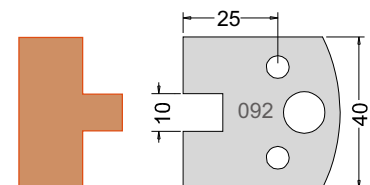

Knife 3309240  
 Limiter 3409240  
 TCT 3309242

### Multi Profile Cutter System - Profile Knives-40mm

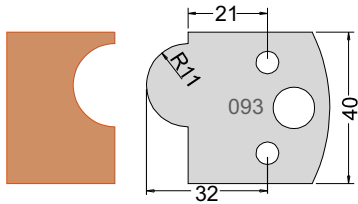

Knife 3309340  
 Limiter 3409340

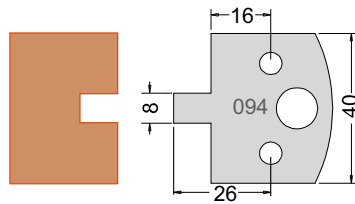

Knife 3309440  
 Limiter 3409440

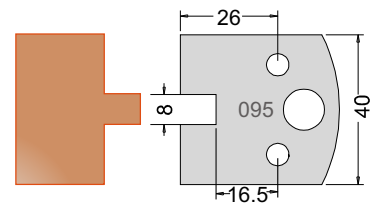

Knife 3309540  
 Limiter 3409540

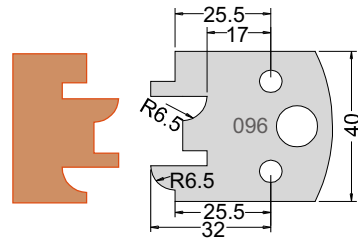

Knife 3309640  
 Limiter 3409640

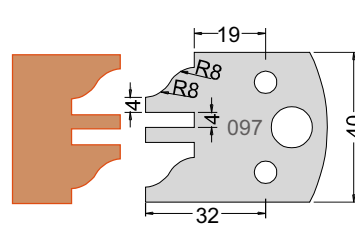

Knife 3309740  
 Limiter 3409740  
 TCT 3309742

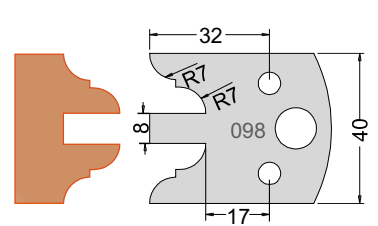

Knife 3309840  
 Limiter 3409840

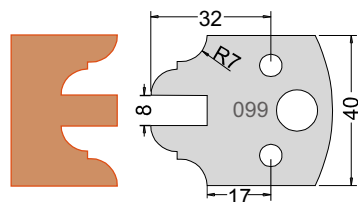

Knife 3309940  
 Limiter 3409940

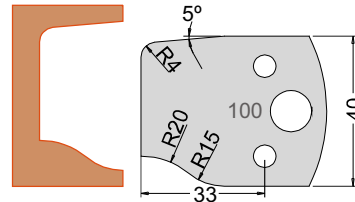

Knife 3310040  
 Limiter 3410040  
 TCT 3310042

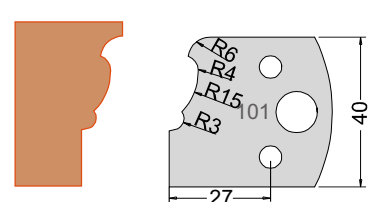

Knife 3310140  
 Limiter 3410140

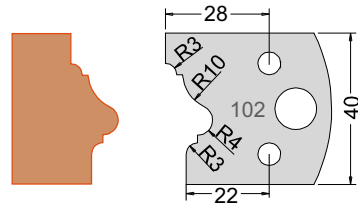

Knife 3310240  
 Limiter 3410240

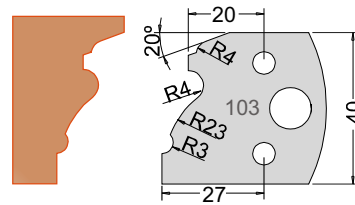

Knife 3310340  
 Limiter 3410340

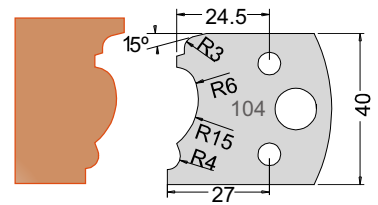

Knife 3310440  
 Limiter 3410440

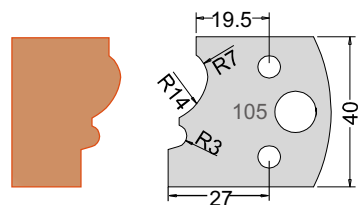

Knife 3310540  
 Limiter 3410540

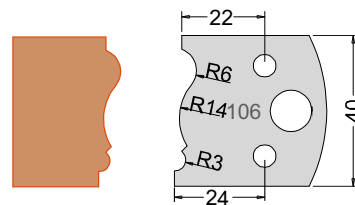

Knife 3310640  
 Limiter 3410640

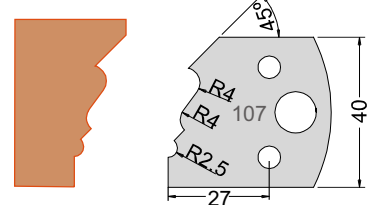

Knife 3310740  
 Limiter 3410740

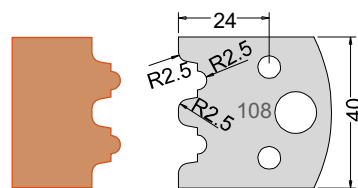

Knife 3310840  
 Limiter 3410840

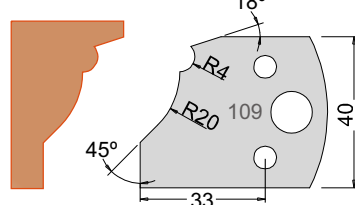

Knife 3310940  
 Limiter 3410940

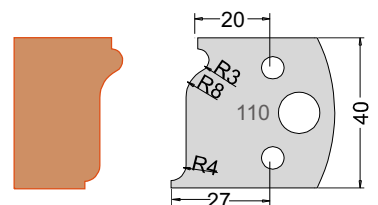

Knife 3311040  
 Limiter 3411040

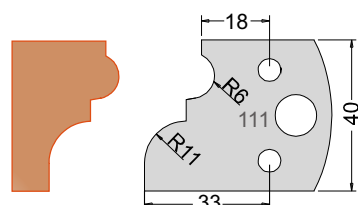

Knife 3311140  
 Limiter 3411140

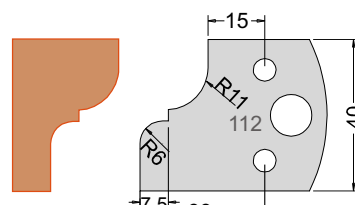

Knife 3311240  
 Limiter 3411240

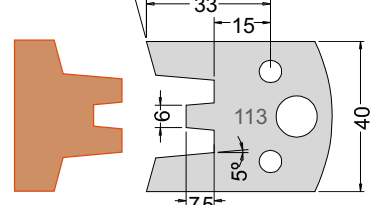

Knife 3311340  
 Limiter 3411340

